

Constant current independent dimmable driver
DEL Series suffix d(DALI-2+pushDIM)



Features

- Support DALI-2+pushDIM dimming mode
- 10-level current output can be realized by DIP-switch
- Soft dimming and flicker-free at any brightness, meets the new requirements of ErP certification
- Using HPC patented technology, at any dimming level, the brightness of the lights is the same
- Dimming range 1~100%, output current accuracy 2%
- Standby power input<0.5W, meets the requirements of ErP certification
- High PF, high efficiency, low THD
- Screw-free and pressing type strain relief, supports thicker cables and is easier to install
- Independent input and output strain relief, stronger wiring
- Intelligent LED hot-plug protection function
- SELV and Class II design, suitable for use outside of the light
- Compliance with CE,ENEC,UKCA,RCM,CCC,DALI-2,EL and other certifications
- IP20 protection grade, indoor use
- Nominal life-time up to 100,000 h
- 5-year guarantee

Interfaces

- DALI-2(DALI-2 DT6)
- PUSH(pushDIM)

Functions

- Support central emergency application (dimming normal in DC input)
- Support self-contained emergency application
- Protective features (short-circuit, overload,no-load, hot plug-in protection)

Suitable for lights

- Suitable for lights with independent drivers such as downlights, spotlights, panel lights, etc
- Not suitable for lights with built-in drivers

Typical applications

- LED indoor lighting
- LED office lighting
- LED commercial lighting



Model coding rules of DEL series

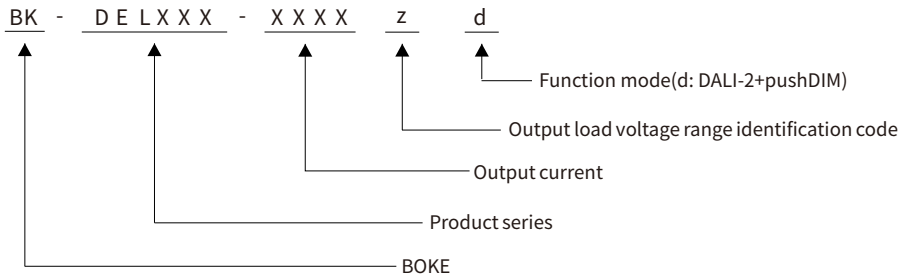

Function list

Model	suffix	Wired dimming	
		DALI-2	pushDIM
BK-DEL010 BK-DEL022 BK-DEL028 BK-DEL030-B BK-DEL042-B BK-DEL060-B	d	√	√

Model list

Model	Input voltage	Output power	Output voltage	Output current	Dimension	Certifications
BK-DEL010-0350Ad	200-240VAC	11W MAX.	6-30/36/4042VDC	0.10-0.35A	L117*W45.5*H24mm	CE, ENEC, UKCA, RCM, CCC, EL, DALI-2
BK-DEL022-0600Ad	200-240VAC	23.1W MAX.	6-38/42VDC	0.225-0.60A	L117*W45.5*H29mm	CE, ENEC, UKCA, RCM, CCC, EL, DALI-2
BK-DEL028-0750Ad	200-240VAC	28.5W MAX.	6-38/40/42VDC	0.30-0.75A	L117*W45.5*H29mm	CE, ENEC, UKCA, RCM, CCC, EL, DALI-2
BK-DEL030-B0800Ad	200-240VAC	30.4W MAX.	6-38/40/42VDC	0.25-0.80A	L103*W68.5*H30.5mm	CE, ENEC, UKCA, RCM, CCC, EL, DALI-2
BK-DEL042-B0800Bd	200-240VAC	38.4W MAX.	6-48VDC	0.25-0.80A	L103*W68.5*H30.5mm	CE, ENEC, UKCA, RCM, CCC, EL, DALI-2
BK-DEL042-B1100Ad	200-240VAC	42W MAX.	6-38/40/42VDC	0.45-1.10A	L103*W68.5*H30.5mm	CE, ENEC, UKCA, RCM, CCC, EL, DALI-2
BK-DEL060-B2000Ad	200-240VAC	61.2W MAX.	6-30/32/34/36/38/40/42VDC	0.80-2.00A	L123.5*W79.5*H31mm	CE, ENEC, UKCA, RCM, CCC, EL, DALI-2

Technical data

Product model	BK-DEL010-0350Ad
Output parameters	
Regulation method	Constant Current
Rated output current range	0.1-0.35A
Rated output voltage range	6-30/36/40/42VDC
Rated output power	10.5W Max
Output current adjustment	DIP S.W(10 levels)
Output current ripple LF	±2%
Output current accuracy	±2%
Linear regulation	±1%
Load regulation	±1%
No load output voltage	50VDC
Flicker-free(typical)	Flickering percent(IEEE 1789)=0.378%, Flicker index(IEEE 1789)=0.001, Pst LM = 0.007, SVM = 0.004, (The above parameters are obtained from testing the panel lights)
Input parameters	
Rated input voltage range	200-240VAC 200-240VDC
Input voltage range	180-264VAC 200-264VDC
Input voltage shock	<380 V AC
Input current	<0.07A (Rated input voltage)
Input frequency	0/50/60Hz
Input PF/Input DF	PF>0.95 (230V AC & Full load), DF>0.95 (230V AC & Full load)
Input THD	10% (230V AC & Full load)
Efficiency(typical)	84% (230V AC & Full load)
In-rush current	4A peak ,160us duration(50 % Ipeak), see the description below for details
Start/Switchover/Turn off	<0.7s(AC start),<0.7s(DC start),<0.3s(AC/DC switchover),<0.5s(Turn off)
Switching cycles	> 50,000 switching cycles
Power consumption	Full load(Pin):13.2W, No load(Pno): N/A, On stand-by(Psb) : <0.5W, Network stand-by(Pnet) : N/A
Safety	
Withstand voltage	I/P-O/P(LED):3750V AC, I/P-DALI: 1500V AC, O/P-DALI: 1500V AC.
Mains surge capability	L-N:2KV(Performance criterion:A)
Leakage current	0.24mA (230V AC & Full load)
Isolation resistance	I/P-O/P:100MΩ/500Vdc/25°C/70% RH
Control interface	
DALI dimming port	Voltage range: 9.5-22.5V, typical 16V, interface current consumption: 1.8mA
pushDIM dimming port	Voltage range: 180-264V 47/63Hz
1-10V 3in1 dimming port	N/A
Auxiliary power supply	N/A
Dimming range	1-100%
Dimming drive mode	AM(amplitude modulation)
Emergency support	
Central emergency system	Supported(dimming normal in DC input)
Self-contained emergency	Supported
Environment & Life time	
Operating temperature	Ta=-20-60°C
Case temperature	Tc=90°C
Operating humidity	5-85% RH, not condensed
Storage temp./humidity	-40-80°C, 5-85% RH, not condensed
IP grade	IP20
MTBF	500,000H,MIL-HDBK-217F(25°C)
Life-time	Nominal life-time up to 100,000 h, see the description below for details
Vibration resistant	10~500Hz,5G 12min./1cycle,period for 72min. each along X,Y,Z axes
Acoustic Noise	<25dB(30cm, Normal operation)
Environmental protection	RoHS
Certifications and standards	
Certification	CE, ENEC, UKCA, RCM, CCC, EL, DALI-2
Safety	EN61347-1, EN61347-2-13, EN62384
EMC	EN55015, EN61000-3-2, EN61000-3-3, EN61000-4-2,3,4,5,6,8,11, EN61547
DALI-2	IEC 62386-101(DALI-2), IEC 62386-102(DALI-2), IEC 62386-207(DALI-2)
EL	Compatible IEC 61347-2- 13 Annex J, compatible with EN 60598-2-22 and EN 50172
RF	N/A

Remarks

- 1.By default, all parameter are measured at 230VAC input, full load and 25°C of ambient temperature.
- 2.The driver can not be installed inside the light. when the driver is used with the light, the EMC of the whole light needs to be tested.

Technical data

Product model	BK-DEL022-0600Ad
Output parameters	
Regulation method	Constant Current
Rated output current range	0.225-0.6A
Rated output voltage range	6-38/42VDC
Rated output power	23.1W Max
Output current adjustment	DIP S.W(10 levels)
Output current ripple LF	±2%
Output current accuracy	±2%
Linear regulation	±1%
Load regulation	±1%
No load output voltage	50VDC
Flicker-free(typical)	Flickering percent(IEEE 1789)=0.782%, Flicker index(IEEE 1789)=0.003, Pst LM = 0.011, SVM = 0.005, (The above parameters are obtained from testing the panel lights)
Input parameters	
Rated input voltage range	200-240VAC 200-240VDC
Input voltage range	180-264VAC 200-264VDC
Input voltage shock	<380 V AC
Input current	<0.14A (Rated input voltage)
Input frequency	0/50/60Hz
Input PF/Input DF	PF>0.95 (230V AC & Full load), DF>0.95 (230V AC & Full load)
Input THD	10% (230V AC & Full load)
Efficiency(typical)	86% (230V AC & Full load)
In-rush current	6.5A peak ,192us duration(50 % Ipeak), see the description below for details
Start/Switchover/Turn off	<0.7s(AC start),<0.7s(DC start),<0.3s(AC/DC switchover),<0.5s(Turn off)
Switching cycles	> 50,000 switching cycles
Power consumption	Full load(Pin):27W, No load(Pno): N/A, On stand-by(Psb) : <0.5W, Network stand-by(Pnet) : N/A
Safety	
Withstand voltage	I/P-O/P(LED):3750V AC, I/P-DALI: 1500V AC, O/P-DALI: 1500V AC.
Mains surge capability	L-N:2KV(Performance criterion:A)
Leakage current	0.27mA (230V AC & Full load)
Isolation resistance	I/P-O/P:100MΩ/500Vdc/25°C/70% RH
Control interface	
DALI dimming port	Voltage range: 9.5-22.5V, typical 16V, interface current consumption: 1.8mA
pushDIM dimming port	Voltage range: 180-264V 47/63Hz
1-10V 3in1 dimming port	N/A
Auxiliary power supply	N/A
Dimming range	1-100%
Dimming drive mode	AM(amplitude modulation)
Emergency support	
Central emergency system	Supported(dimming normal in DC input)
Self-contained emergency	Supported
Environment & Life time	
Operating temperature	Ta=-20-50°C
Case temperature	Tc=90°C
Operating humidity	5-85% RH, not condensed
Storage temp./humidity	-40-80°C, 5-85% RH, not condensed
IP grade	IP20
MTBF	500,000H,MIL-HDBK-217F(25°C)
Life-time	Nominal life-time up to 100,000 h, see the description below for details
Vibration resistant	10~500Hz,5G 12min./1cycle,period for 72min. each along X,Y,Z axes
Acoustic Noise	<25dB(30cm, Normal operation)
Environmental protection	RoHS
Certifications and standards	
Certification	CE, ENEC, UKCA, RCM, CCC, EL, DALI-2
Safety	EN61347-1, EN61347-2-13, EN62384
EMC	EN55015, EN61000-3-2, EN61000-3-3, EN61000-4-2,3,4,5,6,8,11, EN61547
DALI-2	IEC 62386-101(DALI-2), IEC 62386-102(DALI-2), IEC 62386-207(DALI-2)
EL	Compatible IEC 61347-2- 13 Annex J, compatible with EN 60598-2-22 and EN 50172
RF	N/A

Remarks

- 1.By default, all parameter are measured at 230VAC input, full load and 25°C of ambient temperature.
- 2.The driver can not be installed inside the light. when the driver is used with the light, the EMC of the whole light needs to be tested.

Technical data

Product model	BK-DEL028-0750Ad
Output parameters	
Regulation method	Constant Current
Rated output current range	0.3-0.75A
Rated output voltage range	6-38/40/42VDC
Rated output power	28.5W Max
Output current adjustment	DIP S.W(10 levels)
Output current ripple LF	±2%
Output current accuracy	±2%
Linear regulation	±1%
Load regulation	±1%
No load output voltage	50VDC
Flicker-free(typical)	Flickering percent(IEEE 1789)=0.902%, Flicker index(IEEE 1789)=0.003, Pst LM = 0.005, SVM = 0.010, (The above parameters are obtained from testing the panel lights)
Input parameters	
Rated input voltage range	200-240VAC 200-240VDC
Input voltage range	180-264VAC 200-264VDC
Input voltage shock	<380 V AC
Input current	<0.18A (Rated input voltage)
Input frequency	0/50/60Hz
Input PF/Input DF	PF>0.95 (230V AC & Full load), DF>0.95 (230V AC & Full load)
Input THD	10% (230V AC & Full load)
Efficiency(typical)	86% (230V AC & Full load)
In-rush current	6.5A peak ,194us duration(50 % Ipeak), see the description below for details
Start/Switchover/Turn off	<0.7s(AC start),<0.7s(DC start),<0.3s(AC/DC switchover),<0.5s(Turn off)
Switching cycles	> 50,000 switching cycles
Power consumption	Full load(Pin):33.3W, No load(Pno): N/A, On stand-by(Psb) : <0.5W, Network stand-by(Pnet) : N/A
Safety	
Withstand voltage	I/P-O/P(LED):3750V AC, I/P-DALI: 1500V AC, O/P-DALI: 1500V AC.
Mains surge capability	L-N:2KV(Performance criterion:A)
Leakage current	0.33mA (230V AC & Full load)
Isolation resistance	I/P-O/P:100MΩ/500Vdc/25°C/70% RH
Control interface	
DALI dimming port	Voltage range: 9.5-22.5V, typical 16V, interface current consumption: 1.8mA
pushDIM dimming port	Voltage range: 180-264V 47/63Hz
1-10V 3in1 dimming port	N/A
Auxiliary power supply	N/A
Dimming range	1-100%
Dimming drive mode	AM(amplitude modulation)
Emergency support	
Central emergency system	Supported(dimming normal in DC input)
Self-contained emergency	Supported
Environment & Life time	
Operating temperature	Ta=-20-45°C
Case temperature	Tc=90°C
Operating humidity	5-85% RH, not condensed
Storage temp./humidity	-40-80°C, 5-85% RH, not condensed
IP grade	IP20
MTBF	500,000H,MIL-HDBK-217F(25°C)
Life-time	Nominal life-time up to 100,000 h, see the description below for details
Vibration resistant	10~500Hz,5G 12min./1cycle,period for 72min. each along X,Y,Z axes
Acoustic Noise	<25dB(30cm, Normal operation)
Environmental protection	RoHS
Certifications and standards	
Certification	CE, ENEC, UKCA, RCM, CCC, EL, DALI-2
Safety	EN61347-1, EN61347-2-13, EN62384
EMC	EN55015, EN61000-3-2 , EN61000-3-3, EN61000-4-2,3,4,5,6,8,11, EN61547
DALI-2	IEC 62386-101(DALI-2), IEC 62386-102(DALI-2), IEC 62386-207(DALI-2)
EL	Compatible IEC 61347-2- 13 Annex J, compatible with EN 60598-2-22 and EN 50172
RF	N/A

Remarks

- 1.By default, all parameter are measured at 230VAC input, full load and 25°C of ambient temperature.
- 2.The driver can not be installed inside the light. when the driver is used with the light, the EMC of the whole light needs to be tested.

Technical data

Product model	BK-DEL030-B0800Ad
Output parameters	
Regulation method	Constant Current
Rated output current range	0.25-0.8A
Rated output voltage range	6-38/40/42VDC
Rated output power	30.4W Max
Output current adjustment	DIP S.W(16 levels)
Output current ripple LF	±2%
Output current accuracy	±2%
Linear regulation	±1%
Load regulation	±1%
No load output voltage	50VDC
Flicker-free(typical)	Flickering percent(IEEE 1789)=0.757%, Flicker index(IEEE 1789)=0.002, Pst LM = 0.002, SVM = 0.003, (The above parameters are obtained from testing the panel lights)
Input parameters	
Rated input voltage range	200-240VAC 200-240VDC
Input voltage range	180-264VAC 200-264VDC
Input voltage shock	<380 V AC
Input current	<0.18A (Rated input voltage)
Input frequency	0/50/60Hz
Input PF/Input DF	PF>0.95 (230V AC & Full load), DF>0.95 (230V AC & Full load)
Input THD	7% (230V AC & Full load)
Efficiency(typical)	85% (230V AC & Full load)
In-rush current	3.95A peak ,180us duration(50 % Ipeak), see the description below for details
Start/Switchover/Turn off	<0.7s(AC start),<0.7s(DC start),<0.3s(AC/DC switchover),<0.5s(Turn off)
Switching cycles	> 50,000 switching cycles
Power consumption	Full load(Pin):35.1W, No load(Pno): N/A, On stand-by(Psb) : <0.5W, Network stand-by(Pnet) : N/A
Safety	
Withstand voltage	I/P-O/P:3750V AC, I/P-DALI: 1500V AC, O/P-DALI: 1500V AC.
Mains surge capability	L-N:2KV(Performance criterion:A)
Leakage current	0.36mA (230V AC & Full load)
Isolation resistance	I/P-O/P:100MΩ/500Vdc/25°C/70% RH
Control interface	
DALI dimming port	Voltage range: 9.5-22.5V, typical 16V, interface current consumption: 1.8mA
pushDIM dimming port	Voltage range: 180-264V 47/63Hz
1-10V 3in1 dimming port	N/A
Auxiliary power supply	N/A
Dimming range	1%-100%
Dimming drive mode	AM(amplitude modulation)
Emergency support	
Central emergency system	Supported(dimming normal in DC input)
Self-contained emergency	Supported
Environment & Life time	
Operating temperature	Ta=-20-45°C
Case temperature	Tc=90°C
Operating humidity	5-85% RH, not condensed
Storage temp./humidity	-40-80°C, 5-85% RH, not condensed
IP grade	IP20
MTBF	500,000H,MIL-HDBK-217F(25°C)
Life-time	Nominal life-time up to 100,000 h, see the description below for details
Vibration resistant	10~500Hz,5G 12min./1cycle,period for 72min. each along X,Y,Z axes
Acoustic Noise	<25dB(30cm, Normal operation)
Environmental protection	RoHS
Certifications and standards	
Certification	CE, ENEC, UKCA, RCM, CCC, EL, DALI-2
Safety	EN61347-1, EN61347-2-13, EN62384
EMC	EN55015, EN61000-3-2 , EN61000-3-3, EN61000-4-2,3,4,5,6,8,11, EN61547
DALI-2	IEC 62386-101(DALI-2), IEC 62386-102(DALI-2), IEC 62386-207(DALI-2)
EL	Compatible IEC 61347-2- 13 Annex J , compatible with EN 60598-2-22 and EN 50172
RF	N/A

Remarks

- 1.By default, all parameter are measured at 230VAC input, full load and 25°C of ambient temperature.
- 2.The driver can not be installed inside the light. when the driver is used with the light, the EMC of the whole light needs to be tested.

Technical data

Product model	BK-DEL042-B0800Bd
Output parameters	
Regulation method	Constant Current
Rated output current range	0.25-0.8A
Rated output voltage range	6-48VDC
Rated output power	38.4W Max
Output current adjustment	DIP S.W(16 levels)
Output current ripple LF	±2%
Output current accuracy	±2%
Linear regulation	±1%
Load regulation	±1%
No load output voltage	60VDC
Flicker-free(typical)	Flickering percent(IEEE 1789)=0.339%, Flicker index(IEEE 1789)=0.001, Pst LM = 0.000, SVM = 0.001, (The above parameters are obtained from testing the panel lights)
Input parameters	
Rated input voltage range	200-240VAC 200-240VDC
Input voltage range	180-264VAC 200-264VDC
Input voltage shock	<380 V AC
Input current	<0.22A (Rated input voltage)
Input frequency	0/50/60Hz
Input PF/Input DF	PF>0.95 (230V AC & Full load), DF>0.95 (230V AC & Full load)
Input THD	10% (230V AC & Full load)
Efficiency(typical)	88% (230V AC & Full load)
In-rush current	7.9A peak ,180us duration(50 % Ipeak), see the description below for details
Start/Switchover/Turn off	<0.7s(AC start),<0.7s(DC start),<0.3s(AC/DC switchover),<0.5s(Turn off)
Switching cycles	> 50,000 switching cycles
Power consumption	Full load(Pin):42.9W, No load(Pno): N/A, On stand-by(Psb) : <0.5W, Network stand-by(Pnet) : N/A
Safety	
Withstand voltage	I/P-O/P:3750V AC, I/P-DALI: 1500V AC, O/P-DALI: 1500V AC.
Mains surge capability	L-N:2KV(Performance criterion:A)
Leakage current	0.41mA (230V AC & Full load)
Isolation resistance	I/P-O/P:100MΩ/500Vdc/25°C/70% RH
Control interface	
DALI dimming port	Voltage range: 9.5-22.5V, typical 16V, interface current consumption: 1.8mA
pushDIM dimming port	Voltage range: 180-264V 47/63Hz
1-10V 3in1 dimming port	N/A
Auxiliary power supply	N/A
Dimming range	1%-100%
Dimming drive mode	AM(amplitude modulation)
Emergency support	
Central emergency system	Supported(dimming normal in DC input)
Self-contained emergency	Supported
Environment & Life time	
Operating temperature	Ta=-20-45°C
Case temperature	Tc=90°C
Operating humidity	5-85% RH, not condensed
Storage temp./humidity	-40-80°C, 5-85% RH, not condensed
IP grade	IP20
MTBF	500,000H,MIL-HDBK-217F(25°C)
Life-time	Nominal life-time up to 100,000 h, see the description below for details
Vibration resistant	10~500Hz,5G 12min./1cycle,period for 72min. each along X,Y,Z axes
Acoustic Noise	<25dB(30cm, Normal operation)
Environmental protection	RoHS
Certifications and standards	
Certification	CE, ENEC, UKCA, RCM, CCC, EL, DALI-2
Safety	EN61347-1, EN61347-2-13, EN62384
EMC	EN55015, EN61000-3-2 , EN61000-3-3, EN61000-4-2,3,4,5,6,8,11, EN61547
DALI-2	IEC 62386-101(DALI-2), IEC 62386-102(DALI-2), IEC 62386-207(DALI-2)
EL	Compatible IEC 61347-2- 13 Annex J , compatible with EN 60598-2-22 and EN 50172
RF	N/A

Remarks

- 1.By default, all parameter are measured at 230VAC input, full load and 25°C of ambient temperature.
- 2.The driver can not be installed inside the light. when the driver is used with the light, the EMC of the whole light needs to be tested.

Technical data

Product model	BK-DEL042-B1100Ad
Output parameters	
Regulation method	Constant Current
Rated output current range	0.45-1.1A
Rated output voltage range	6-38/40/42VDC
Rated output power	42W Max
Output current adjustment	DIP S.W.(16 levels)
Output current ripple LF	±2%
Output current accuracy	±2%
Linear regulation	±1%
Load regulation	±1%
No load output voltage	50VDC
Flicker-free(typical)	Flickering percent(IEEE 1789)=0.177%, Flicker index(IEEE 1789)=0.001, Pst LM = 0.032, SVM = 0.005, (The above parameters are obtained from testing the panel lights)
Input parameters	
Rated input voltage range	200-240VAC 200-240VDC
Input voltage range	180-264VAC 200-264VDC
Input voltage shock	<380 VAC
Input current	<0.25A (Rated input voltage)
Input frequency	0/50/60Hz
Input PF/Input DF	PF>0.95 (230V AC & Full load), DF>0.95 (230V AC & Full load)
Input THD	7% (230V AC & Full load)
Efficiency(typical)	86% (230V AC & Full load)
In-rush current	7.9A peak ,176us duration(50 % Ipeak), see the description below for details
Start/Switchover/Turn off	<0.7s(AC start),<0.7s(DC start),<0.3s(AC/DC switchover),<0.5s(Turn off)
Switching cycles	> 50,000 switching cycles
Power consumption	Full load(Pin):48W, No load(Pno): N/A, On stand-by(Psb) : <0.5W, Network stand-by(Pnet) : N/A
Safety	
Withstand voltage	I/P-O/P:3750V AC, I/P-DALI: 1500V AC, O/P-DALI: 1500V AC.
Mains surge capability	L-N:2KV(Performance criterion:A)
Leakage current	0.41mA (230V AC & Full load)
Isolation resistance	I/P-O/P:100MΩ/500Vdc/25°C/70% RH
Control interface	
DALI dimming port	Voltage range: 9.5-22.5V, typical 16V, interface current consumption: 1.8mA
pushDIM dimming port	Voltage range: 180-264V 47/63Hz
1-10V 3in1 dimming port	N/A
Auxiliary power supply	N/A
Dimming range	1%-100%
Dimming drive mode	AM(amplitude modulation)
Emergency support	
Central emergency system	Supported(dimming normal in DC input)
Self-contained emergency	Supported
Environment & Life time	
Operating temperature	Ta=-20-45°C
Case temperature	Tc=90°C
Operating humidity	5-85% RH, not condensed
Storage temp./humidity	-40-80°C, 5-85% RH, not condensed
IP grade	IP20
MTBF	500,000H,MIL-HDBK-217F(25°C)
Life-time	Nominal life-time up to 100,000 h, see the description below for details
Vibration resistant	10~500Hz,5G 12min./1cycle,period for 72min. each along X,Y,Z axes
Acoustic Noise	<25dB(30cm, Normal operation)
Environmental protection	RoHS
Certifications and standards	
Certification	CE, ENEC, UKCA, RCM, CCC, EL, DALI-2
Safety	EN61347-1, EN61347-2-13, EN62384
EMC	EN55015, EN61000-3-2, EN61000-3-3, EN61000-4-2,3,4,5,6,8,11, EN61547
DALI-2	IEC 62386-101(DALI-2), IEC 62386-102(DALI-2), IEC 62386-207(DALI-2)
EL	Compatible IEC 61347-2- 13 Annex J, compatible with EN 60598-2-22 and EN 50172
RF	N/A

Remarks

- 1.By default, all parameter are measured at 230VAC input, full load and 25°C of ambient temperature.
- 2.The driver can not be installed inside the light. when the driver is used with the light, the EMC of the whole light needs to be tested.

Technical data

Product model	BK-DEL060-B2000Ad
Output parameters	
Regulation method	Constant Current
Rated output current range	0.8-2.0A
Rated output voltage range	6- 30/32/34V36/38/40/42VDC
Rated output power	61.2W Max
Output current adjustment	DIP S.W(16 levels)
Output current ripple LF	±2%
Output current accuracy	±2%
Linear regulation	±1%
Load regulation	±1%
No load output voltage	50VDC
Flicker-free(typical)	Flickering percent(IEEE 1789)=0.203%, Flicker index(IEEE 1789)=0.000, Pst LM = 0.004, SVM = 0.005, (The above parameters are obtained from testing the panel lights)
Input parameters	
Rated input voltage range	200-240VAC 200-240VDC
Input voltage range	180-264VAC 200-264VDC
Input voltage shock	<380 V AC
Input current	<0.36A (Rated input voltage)
Input frequency	0/50/60Hz
Input PF/Input DF	PF>0.95 (230V AC & Full load), DF>0.95 (230V AC & Full load)
Input THD	7% (230V AC & Full load)
Efficiency(typical)	86% (230V AC & Full load)
In-rush current	9.1A peak ,174us duration(50 % Ipeak), see the description below for details
Start/Switchover/Turn off	<0.7s(AC start),<0.7s(DC start),<0.3s(AC/DC switchover),<0.5s(Turn off)
Switching cycles	> 50,000 switching cycles
Power consumption	Full load(Pin):69.2W, No load(Pno): N/A, On stand-by(Psb) : <0.5W, Network stand-by(Pnet) : N/A
Safety	
Withstand voltage	I/P-O/P:3750V AC, I/P-DALI: 1500V AC, O/P-DALI: 1500V AC.
Mains surge capability	L-N:2KV(Performance criterion:A)
Leakage current	0.38mA (230V AC & Full load)
Isolation resistance	I/P-O/P:100MΩ/500Vdc/25°C/70% RH
Control interface	
DALI dimming port	Voltage range: 9.5-22.5V, typical 16V, interface current consumption: 1.8mA
pushDIM dimming port	Voltage range: 180-264V 47/63Hz
1-10V 3in1 dimming port	N/A
Auxiliary power supply	N/A
Dimming range	1%-100%
Dimming drive mode	AM(amplitude modulation)
Emergency support	
Central emergency system	Supported(dimming normal in DC input)
Self-contained emergency	Supported
Environment & Life time	
Operating temperature	Ta=-20-45°C
Case temperature	Tc=90°C
Operating humidity	5-85% RH, not condensed
Storage temp./humidity	-40-80°C, 5-85% RH, not condensed
IP grade	IP20
MTBF	500,000H,MIL-HDBK-217F(25°C)
Life-time	Nominal life-time up to 100,000 h, see the description below for details
Vibration resistant	10~500Hz,5G 12min./1cycle,period for 72min. each along X,Y,Z axes
Acoustic Noise	<25dB(30cm, Normal operation)
Environmental protection	RoHS
Certifications and standards	
Certification	CE, ENEC, UKCA, RCM, CCC, EL, DALI-2
Safety	EN61347-1, EN61347-2-13, EN62384
EMC	EN55015, EN61000-3-2 , EN61000-3-3, EN61000-4-2,3,4,5,6,8,11, EN61547
DALI-2	IEC 62386-101(DALI-2), IEC 62386-102(DALI-2), IEC 62386-207(DALI-2)
EL	Compatible IEC 61347-2- 13 Annex J , compatible with EN 60598-2-22 and EN 50172
RF	N/A

Remarks

- By default, all parameter are measured at 230VAC input, full load and 25°C of ambient temperature.
- The driver can not be installed inside the light. when the driver is used with the light, the EMC of the whole light needs to be tested.

Electrical values

BK-DEL010-0350Ad

Operating window

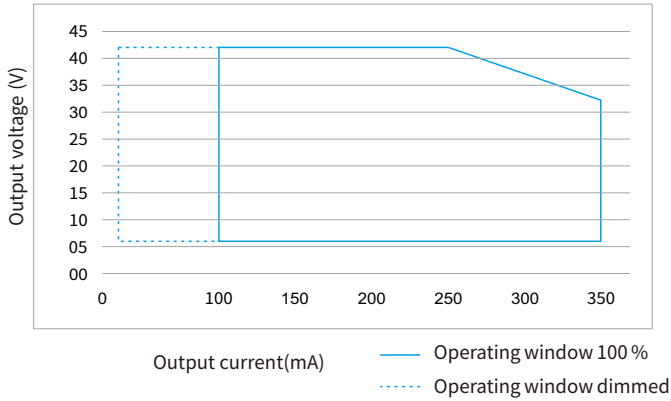

Operating window

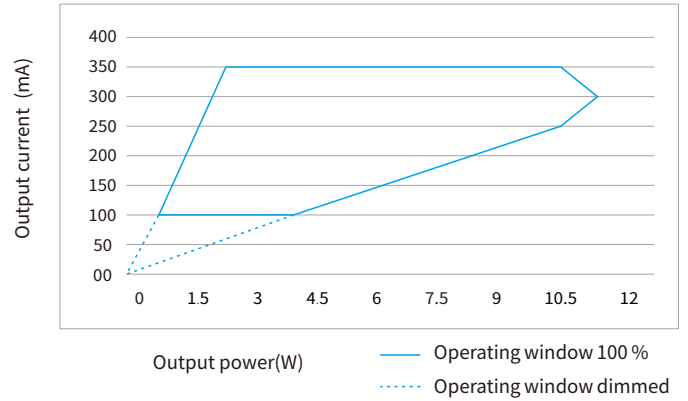

Efficiency vs load

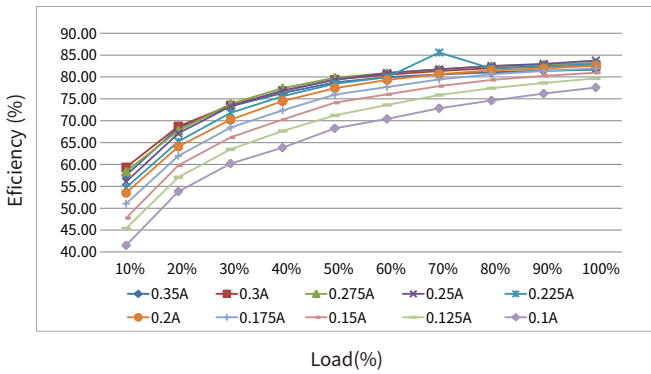

THD vs. Load

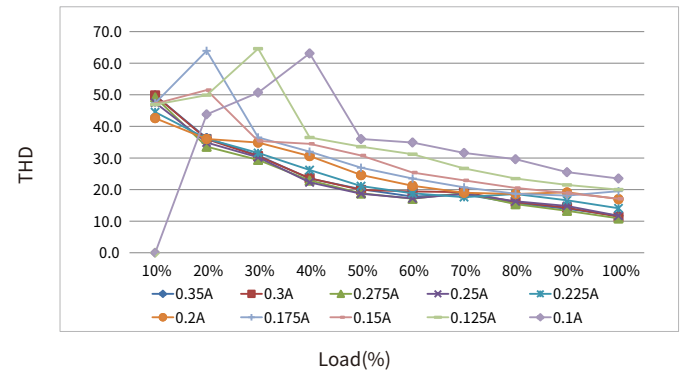

Power factor vs. Load

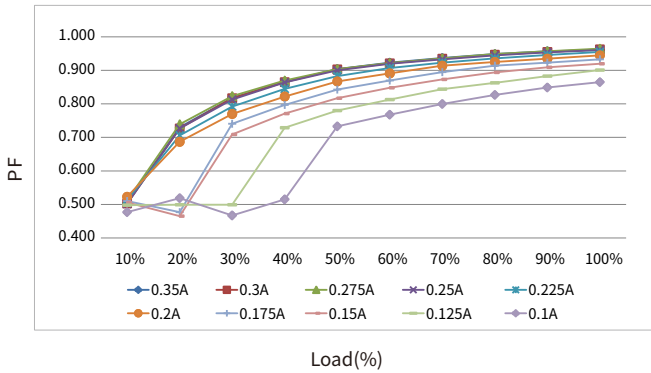

Displacement factor vs. Load

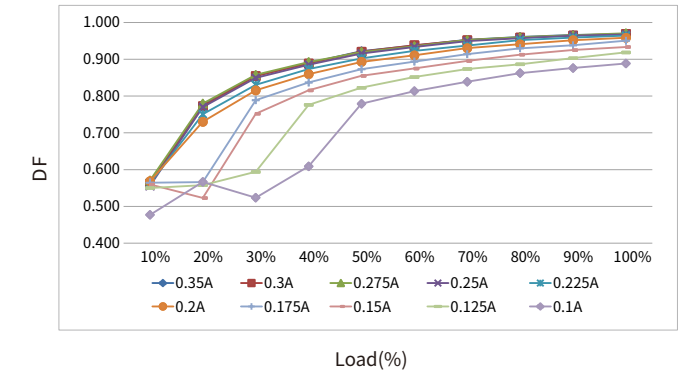

Expected life-time

Life-time vs. case temperature

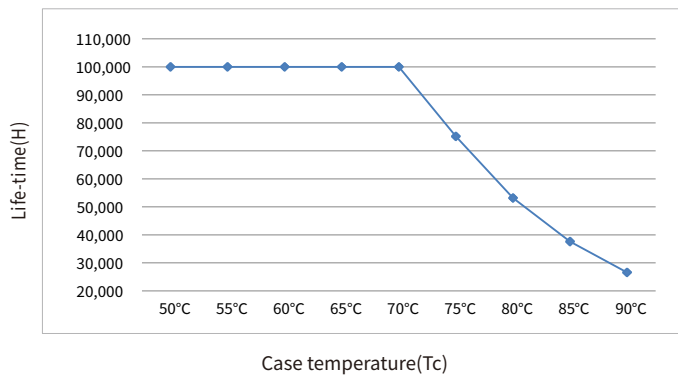

-The life-time of the LED driver is shown in the figure above (calculated based on the 90% survival rate).

- The relation of tc to ta temperature depends also on the luminaire design.

Electrical values

BK-DEL022-0600Ad

Operating window

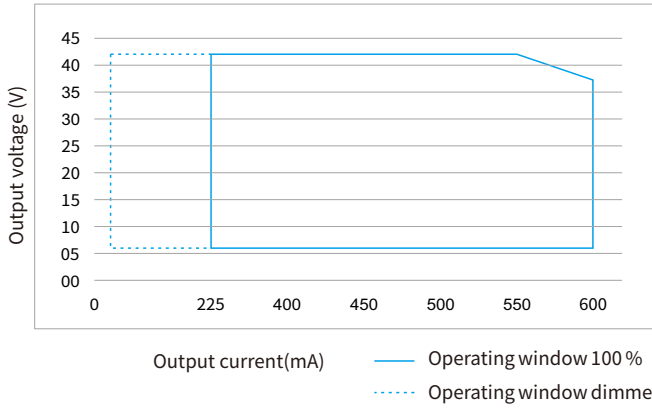

Operating window

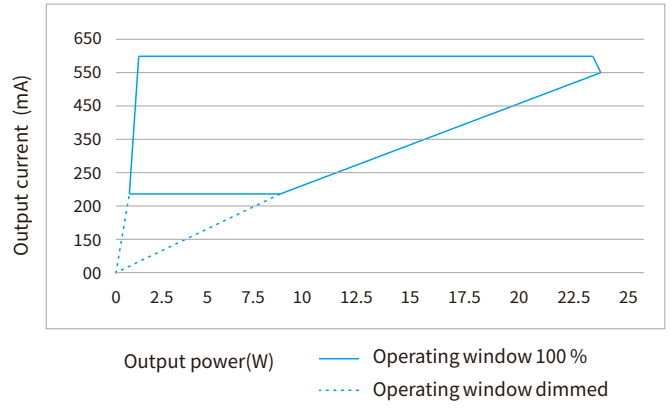

Efficiency vs load

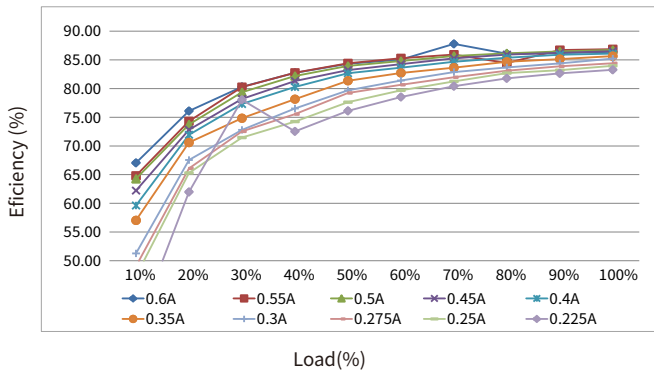

THD vs. Load

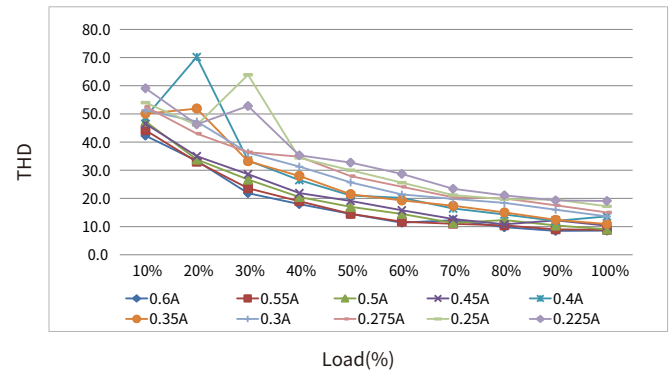

Power factor vs. Load

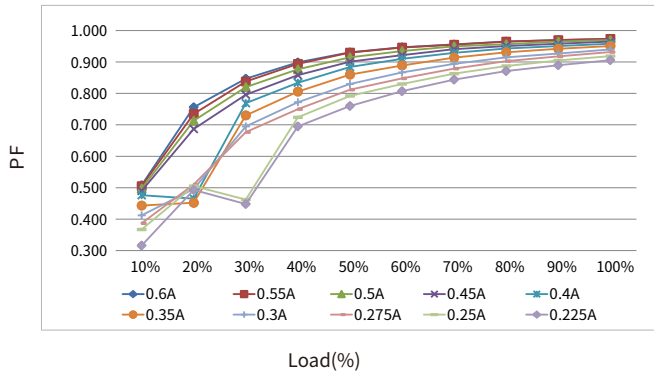

Displacement factor vs. Load

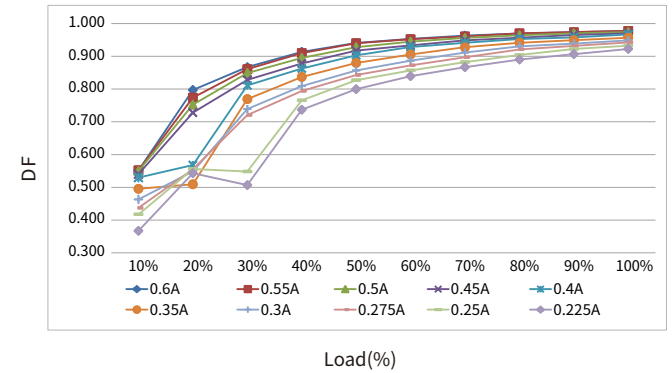

Expected life-time

Life-time vs. case temperature

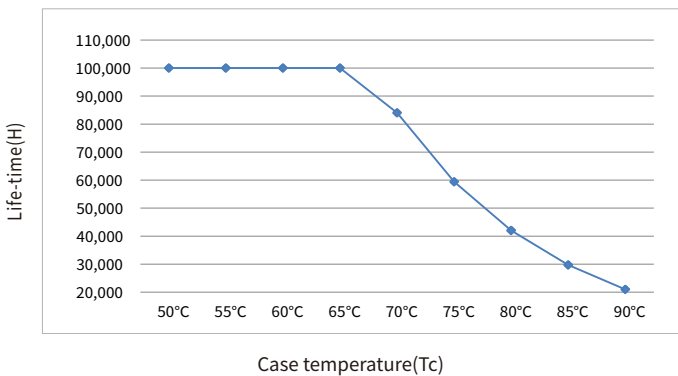

-The life-time of the LED driver is shown in the figure above (calculated based on the 90% survival rate).

- The relation of tc to ta temperature depends also on the luminaire design.

Electrical values

BK-DEL028-0750Ad

Operating window

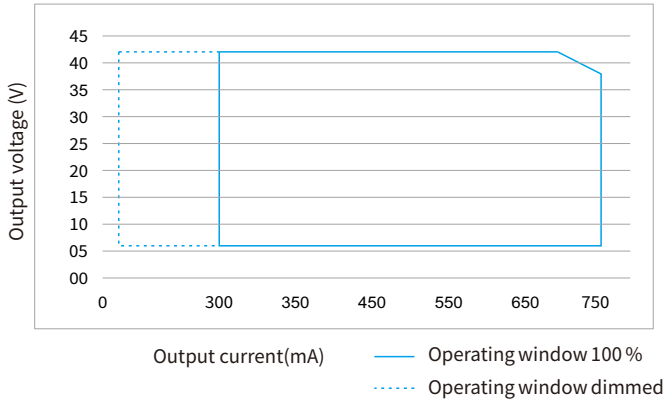

Operating window

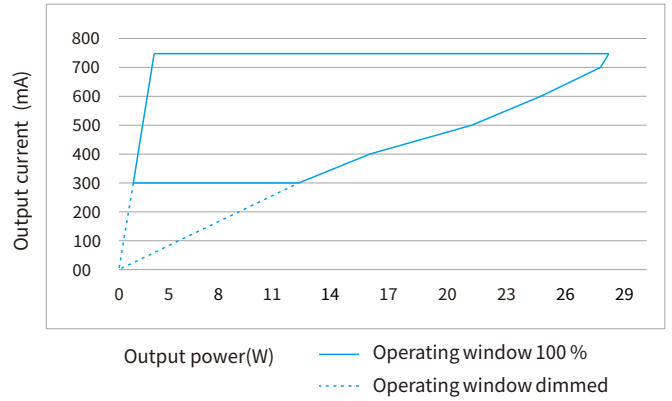

Efficiency vs load

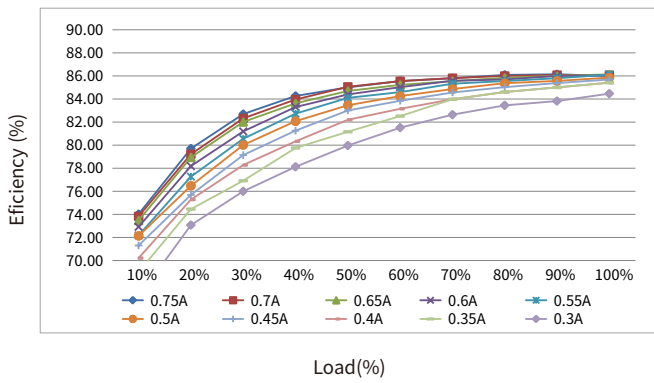

THD vs. Load

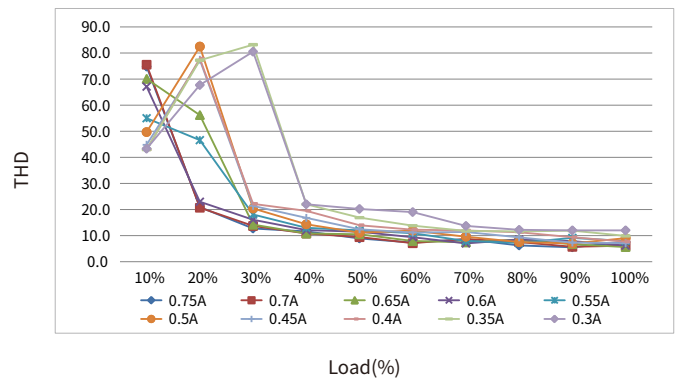

Power factor vs. Load

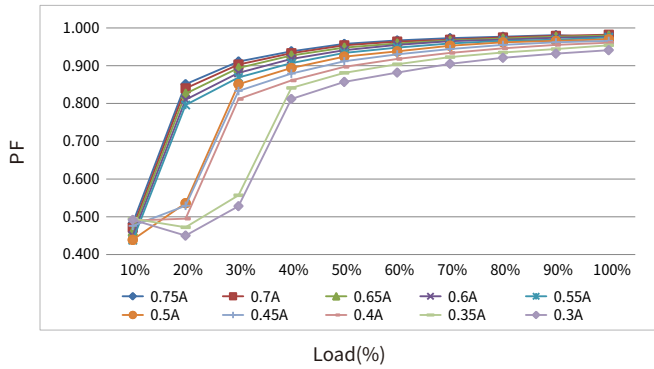

Displacement factor vs. Load

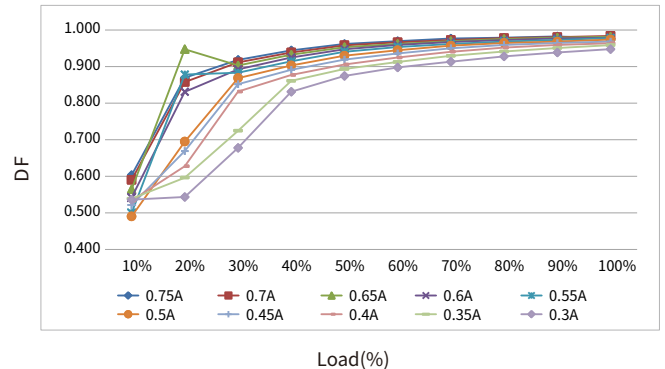

Expected life-time

Life-time vs. case temperature

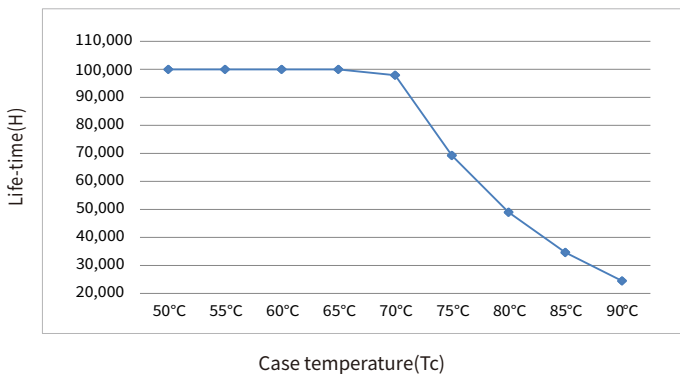

-The life-time of the LED driver is shown in the figure above (calculated based on the 90% survival rate).
 - The relation of t_c to t_a temperature depends also on the luminaire design.

Electrical values

BK-DEL030-B0800Ad

Operating window

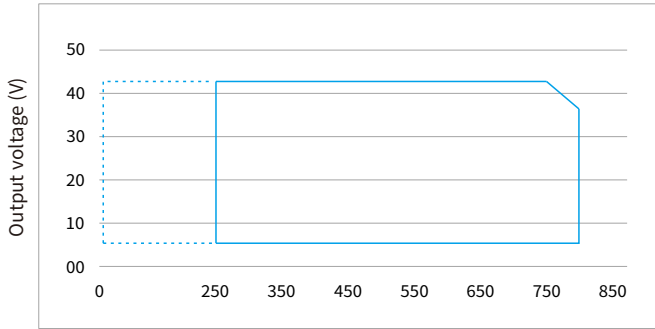

Output current(mA) — Operating window 100 %
 Operating window dimmed

Operating window

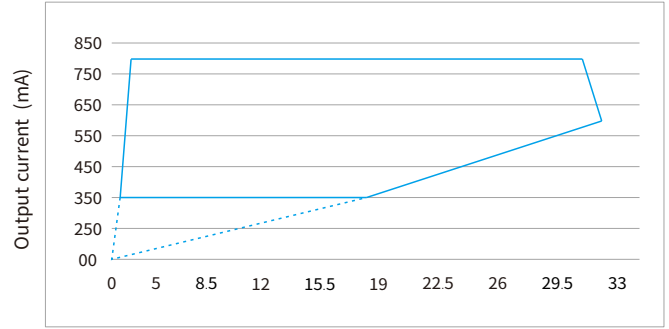

Output power(W) — Operating window 100 %
 Operating window dimmed

Efficiency vs load

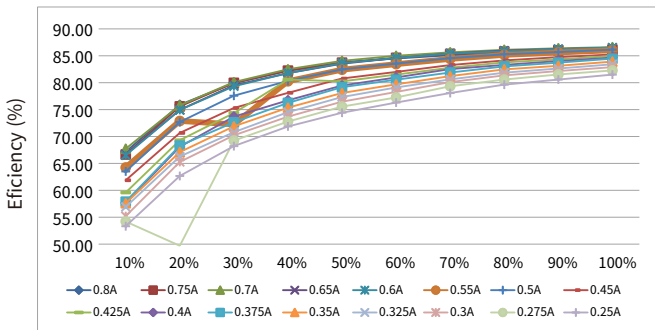

Load(%)

THD vs. Load

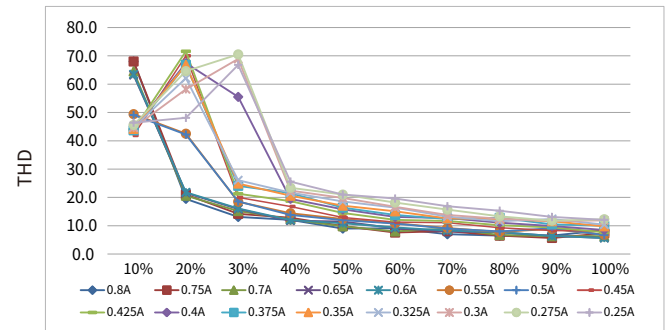

Load(%)

Power factor vs. Load

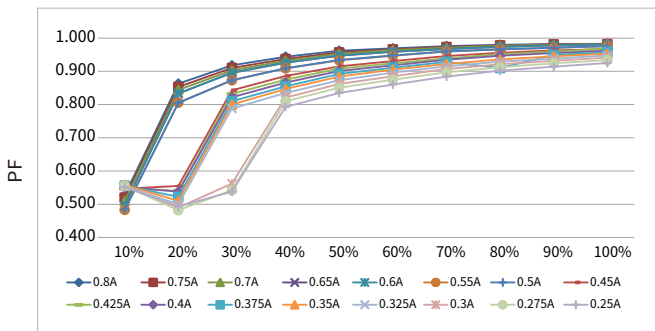

Load(%)

Displacement factor vs. Load

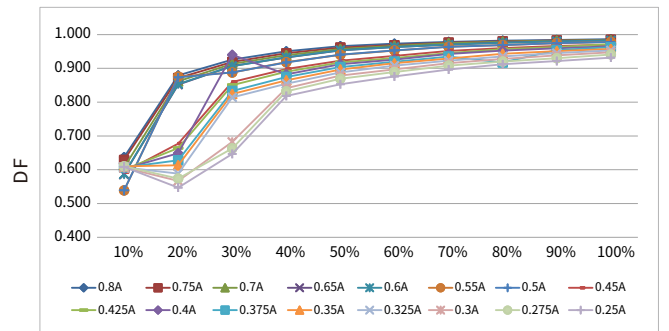

Load(%)

Expected life-time

Life-time vs. case temperature

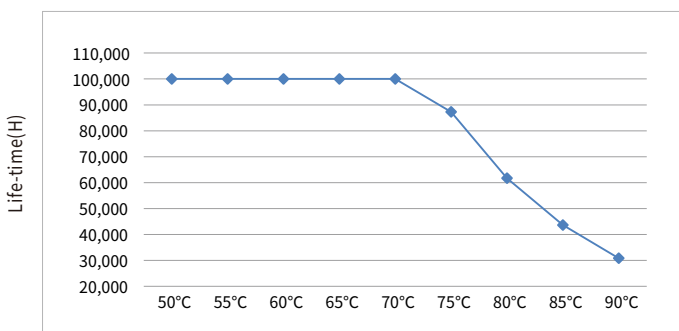

Case temperature(Tc)

-The life-time of the LED driver is shown in the figure above (calculated based on the 90% survival rate).
 - The relation of tc to ta temperature depends also on the luminaire design.

Electrical values

BK-DEL042-B0800Ad

Operating window

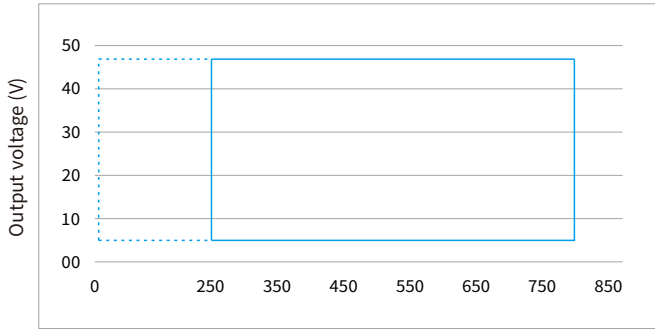

Output current(mA) — Operating window 100 %
 Operating window dimmed

Operating window

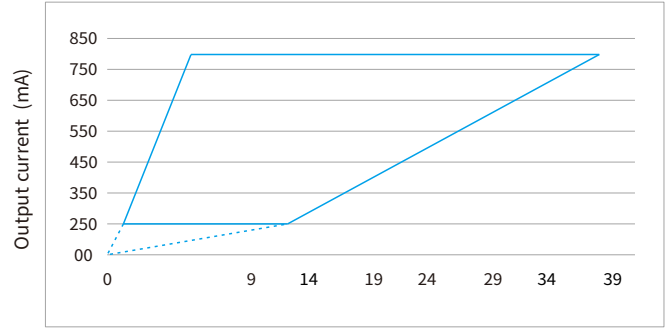

Output power(W) — Operating window 100 %
 Operating window dimmed

Efficiency vs load

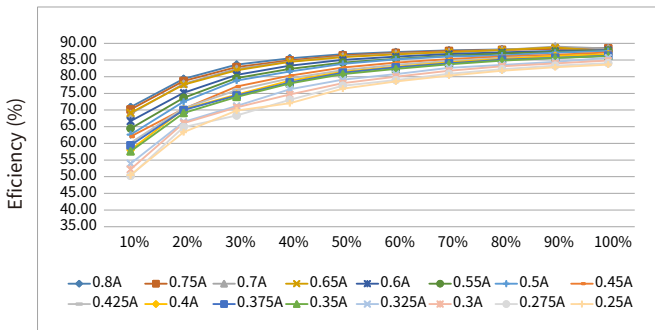

Load(%)

THD vs. Load

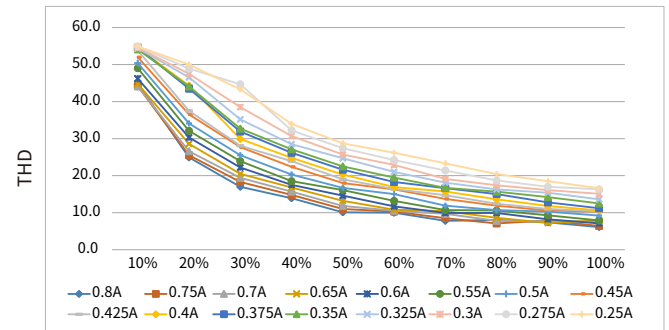

Load(%)

Power factor vs. Load

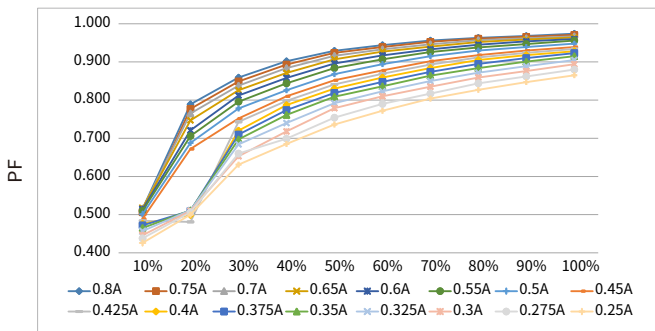

Load(%)

Displacement factor vs. Load

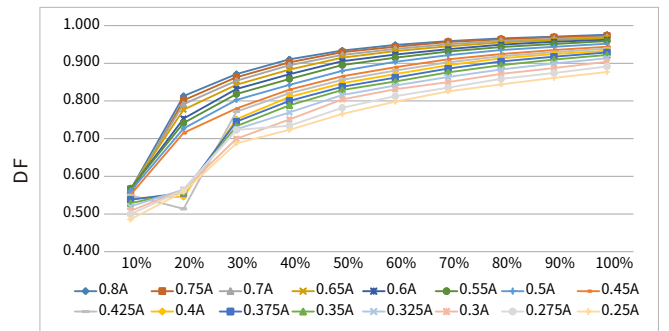

Load(%)

Expected life-time

Life-time vs. case temperature

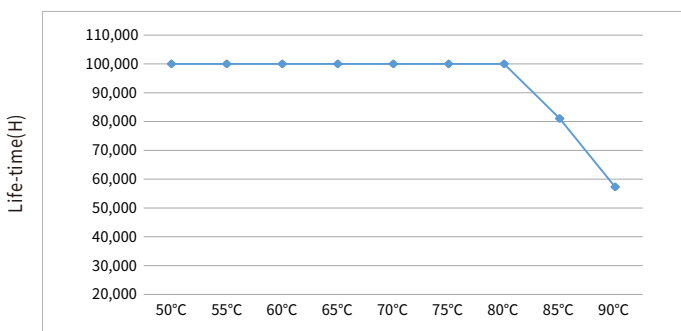

Case temperature(Tc)

-The life-time of the LED driver is shown in the figure above (calculated based on the 90% survival rate).
 - The relation of t_c to t_a temperature depends also on the luminaire design.

Electrical values

BK-DEL042-B1100Ad

Operating window

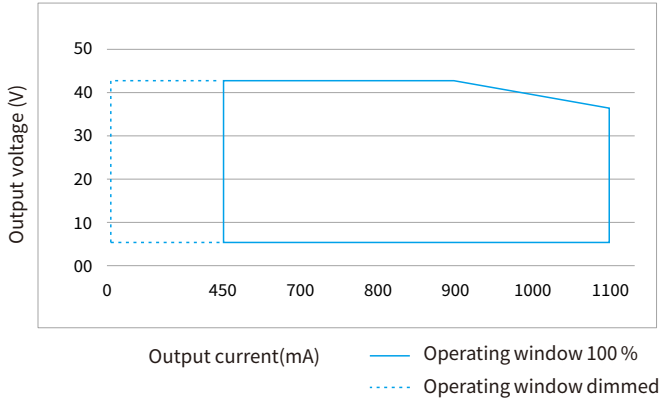

Operating window

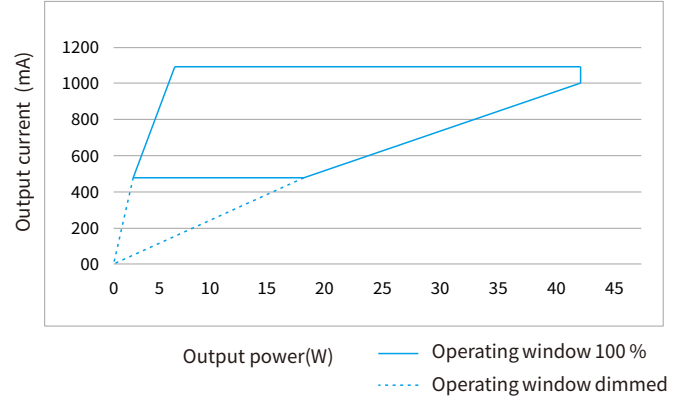

Efficiency vs load

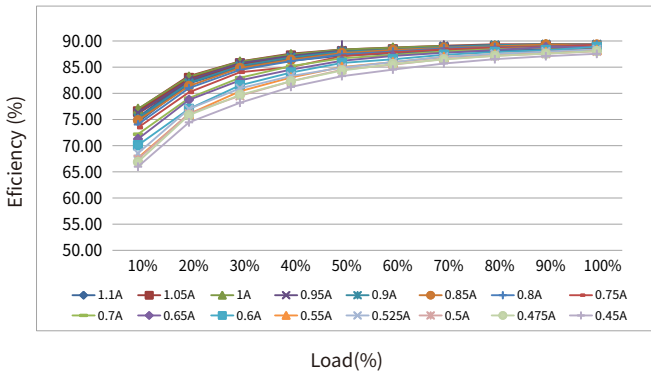

THD vs. Load

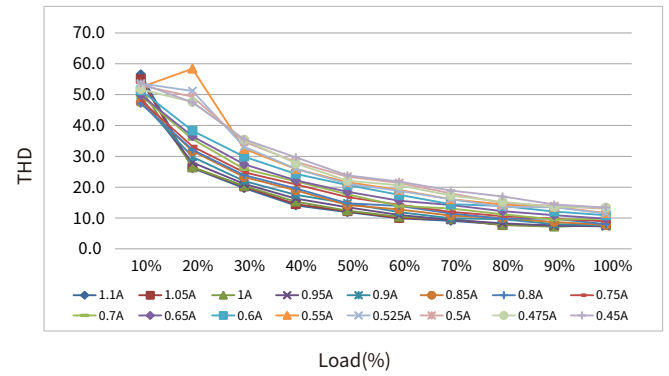

Power factor vs. Load

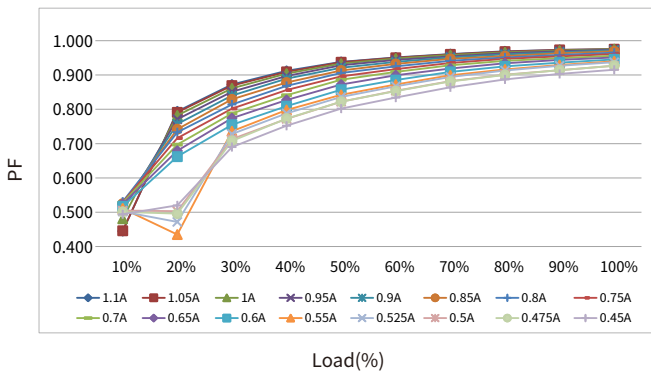

Displacement factor vs. Load

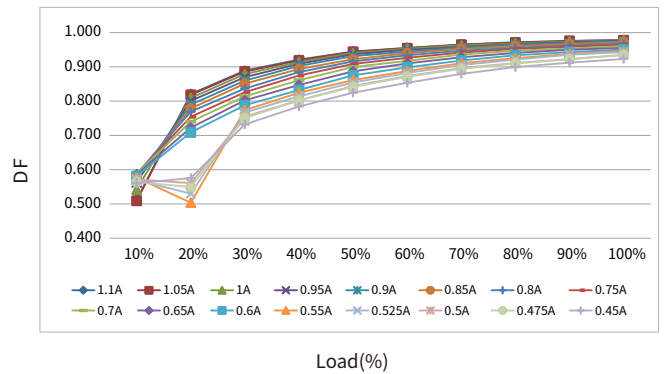

Expected life-time

Life-time vs. case temperature

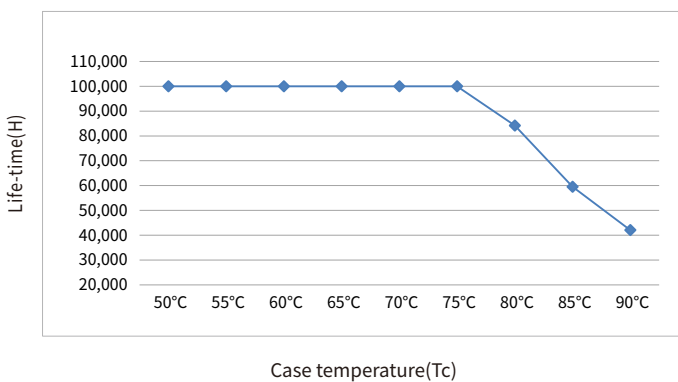

-The life-time of the LED driver is shown in the figure above (calculated based on the 90% survival rate).

- The relation of tc to ta temperature depends also on the luminaire design.

Electrical values

BK-DEL060-B2000Ad

Operating window

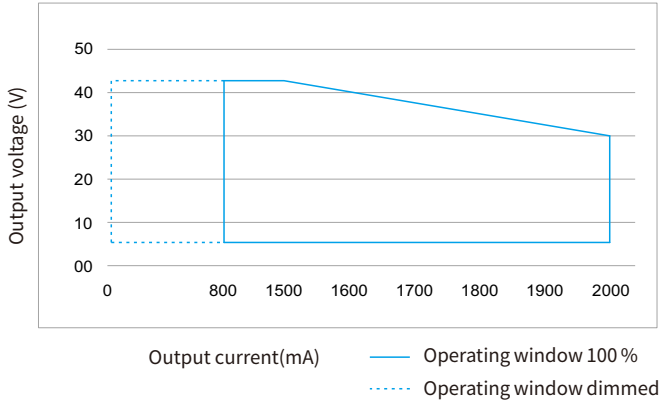

Operating window

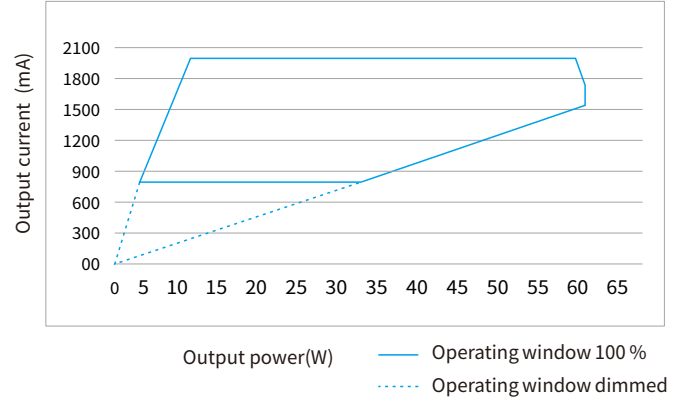

Efficiency vs load

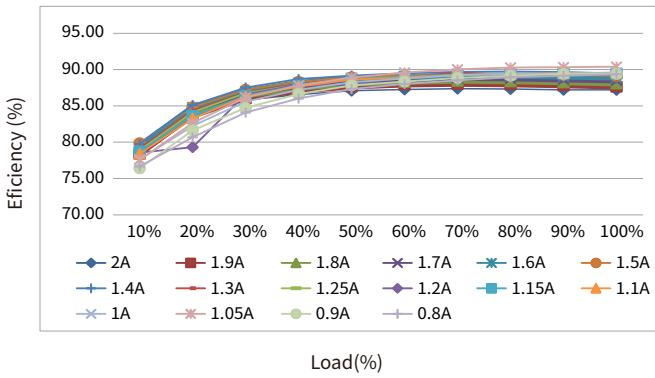

THD vs. Load

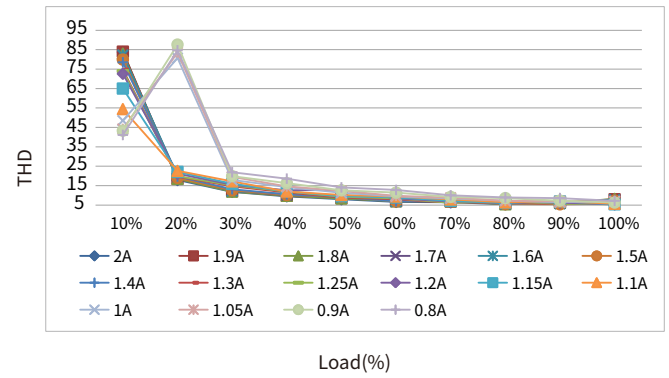

Power factor vs. Load

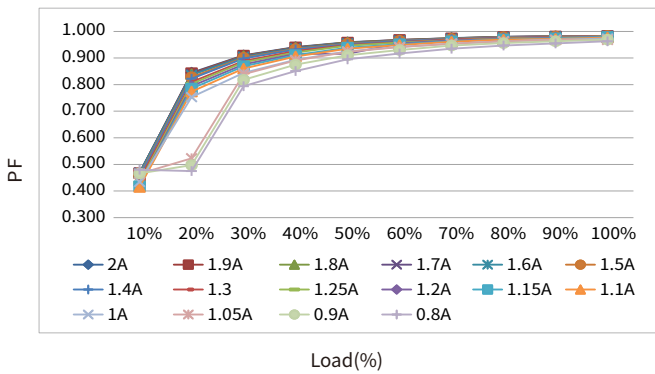

Displacement factor vs. Load

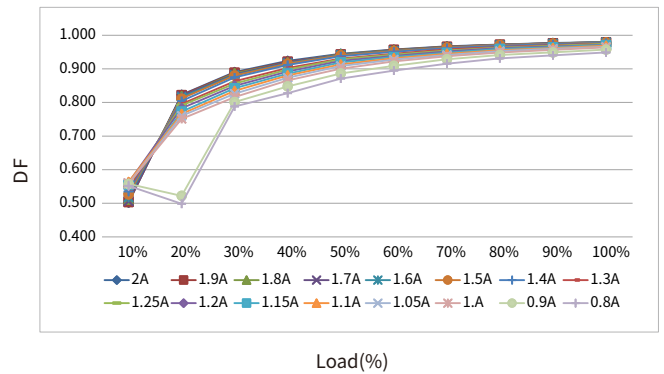

Expected life-time

Life-time vs. case temperature

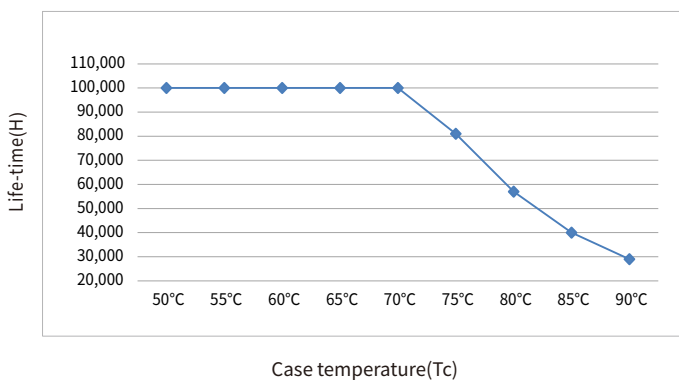

-The life-time of the LED driver is shown in the figure above (calculated based on the 90% survival rate).
 - The relation of tc to ta temperature depends also on the luminaire design.

Surge

Model	Ipeak	Twidth	Condition	Relative number of MCB														
				B10	B13	B16	B20	B25	C10	C13	C16	C20	C25	D10	D13	D16	D20	D25
BK-DEL010-0350Ad	4A	160us	AC 230V, Full load, Cold start, Ta ≤ 30°C, MCB is not installed side by side	99	128	158	197	247	125	162	200	250	312	125	162	200	250	312
BK-DEL022-0600Ad	6.5A	192us		65	65	80	100	124	59	77	94	118	147	59	77	94	118	147
BK-DEL028-0750Ad	6.5A	194us		48	62	77	96	120	48	62	77	96	120	48	62	77	96	120
BK-DEL030-B0800Ad	3.95A	180us		46	60	73	92	114	46	60	73	92	114	46	60	73	92	114
BK-DEL042-B0800Bd	7.9A	180us		36	47	58	73	91	36	47	58	73	91	36	47	58	73	91
BK-DEL042-B1100Ad	7.9A	176us		33	42	52	65	81	33	42	52	65	81	33	42	52	65	81
BK-DEL060-B2000Ad	9.1A	174us		23	29	36	45	57	23	29	36	45	57	23	29	36	45	57

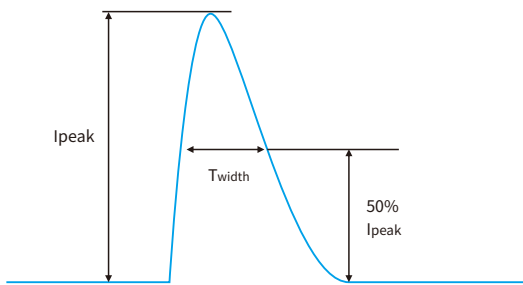

Remarks

- The number of drives mounted under different MCBs in the table is the maximum value. Please do not exceed this number during installation.
- Calculation uses typical values from ABB series S200 as a reference.
- Different brands and models of miniature circuit breakers, the number of drives mounted will be slightly different.
- If the ambient temperature of the MCB installation exceeds 30°C or multiple MCBs are installed side by side, the number of drives mounted will be reduced and the calculation needs to be recalculated.
- Electrician's usually consider Type B for household lighting and Type C for commercial lighting application.

Functions

Output short-circuit behaviour

- Output short-circuit will not damage the driver.
- After removing the short circuit fault, the driver will automatically resume output.

Output no-load operation

- Output no-load will not damage the driver.
- Please turn off the driver first if you need to connect the LED load.

Output overload protection

- The LED driver turns off the output if the output voltage range is exceeded.
- The output will be activated again after restart the LED driver .

Output hot plug-in

In the following two cases, the LED driver will automatically turn off the output to protect the LED:

- When the driver is powered on first and the LED is connected later.
 - When the driver is powered on, disconnected and connected again.
- The output will be activated again after restart of the LED driver .

Driver restart method

There are two ways to restart the driver:

- Through the AC input: disconnect the AC of the driver and power it again.
 - Through dimming interface.
- DALI: send "OFF" command first, then send "MAX" command.
- pushDIM: short press pushbutton two times, then long press pushbutton.

Insulation between circuits

Isolation	Input	Output	Case	DALI	PUSH
Input	-	Double	Double	Basic	-
Output	Double	-	Basic	Double	Double
Case	Double	Basic	-	Double	Double

Label

BK-DEL010-0350Ad

BOKE Dimmable Constant Current LED Driver P E Z L
MODEL: BK-DEL010-0350Ad
 INPUT: 200-240V \approx 0/50/60Hz 0.07A Max. λ : 0.95
 OUTPUT: 6-30V \approx 350mA 10.5W 50VDC Max. MADE IN CHINA
 Other ratings see selection sheet
 For LED Modules use only
 www.bokedriver.com

wire prep. 0.75-1.5mm² Preparation for input and output 8-9mm

■ ACL/DC+ ■ ACN/DC- ■ DA DA L N pushDIM

tc:90°C ta:60°C

For Australia and New Zealand, the marking "label with"

Switching selection sheet

Pin(W) typ.	Output			Switch			
	Prated(w)	Irated(mA)	Voltage(Vdc)	1	2	3	4
6.80	4.20	100	6-42	ON	ON	ON	ON
8.30	5.25	125	6-42	ON	ON	ON	ON
9.80	6.30	150	6-42	ON	ON	ON	ON
11.3	7.35	175	6-42	ON	ON	ON	ON
12.9	8.40	200	6-42	ON	ON	ON	ON
12.9	8.45	225	6-42	ON	ON	ON	ON
13.2	10.5	250	6-42	ON	ON	ON	ON
13.3	11.0	275	6-40	ON	ON	ON	ON
13.1	10.8	300	6-36	ON	ON	ON	ON
12.8	10.5	350	6-30	ON	ON	ON	ON

Do not energize the driver before connecting the LED.

Before use, always check dipswitch settings!

BK-DEL022-0600Ad

BOKE Dimmable Constant Current LED Driver P E Z L
MODEL: BK-DEL022-0600Ad
 INPUT: 200-240V \approx 0/50/60Hz 0.14A Max. λ : 0.95
 OUTPUT: 6-38V \approx 600mA 22.8W 50VDC Max. MADE IN CHINA
 Other ratings see selection sheet
 For LED Modules use only
 www.bokedriver.com

wire prep. 0.75-1.5mm² Preparation for input and output 8-9mm

■ ACL/DC+ ■ ACN/DC- ■ DA DA L N pushDIM

tc:90°C ta:50°C

For Australia and New Zealand, the marking "label with"

Switching selection sheet

Pin(W) typ.	Output			Switch			
	Prated(w)	Irated(mA)	Voltage(Vdc)	1	2	3	4
11.2	9.45	225	6-42	ON	ON	ON	ON
12.3	10.50	250	6-42	ON	ON	ON	ON
13.5	11.55	275	6-42	ON	ON	ON	ON
14.6	12.60	300	6-42	ON	ON	ON	ON
16.9	14.70	350	6-42	ON	ON	ON	ON
19.3	16.80	400	6-42	ON	ON	ON	ON
21.6	18.90	450	6-42	ON	ON	ON	ON
23.9	21.00	500	6-42	ON	ON	ON	ON
26.6	23.10	550	6-42	ON	ON	ON	ON
26.4	22.80	600	6-38	ON	ON	ON	ON

Do not energize the driver before connecting the LED.

Before use, always check dipswitch settings!

BK-DEL028-0750Ad

BOKE Dimmable Constant Current LED Driver P E Z L
MODEL: BK-DEL028-0750Ad
 INPUT: 200-240V \approx 0/50/60Hz 0.18A Max. λ : 0.95
 OUTPUT: 6-38V \approx 750mA 28.5W 50VDC Max. MADE IN CHINA
 Other ratings see selection sheet
 For LED Modules use only
 www.bokedriver.com

wire prep. 0.75-1.5mm² Preparation for input and output 8-9mm

■ ACL/DC+ ■ ACN/DC- ■ DA DA L N pushDIM

tc:90°C ta:45°C

For Australia and New Zealand, the marking "label with"

Switching selection sheet

Pin(W) typ.	Output			Switch			
	Prated(w)	Irated(mA)	Voltage(Vdc)	1	2	3	4
14.8	12.60	300	6-42	ON	ON	ON	ON
17.0	14.70	350	6-42	ON	ON	ON	ON
19.4	16.80	400	6-42	ON	ON	ON	ON
21.6	18.90	450	6-42	ON	ON	ON	ON
24.1	21.00	500	6-42	ON	ON	ON	ON
26.9	23.10	550	6-42	ON	ON	ON	ON
29.2	25.20	600	6-42	ON	ON	ON	ON
31.8	27.30	650	6-42	ON	ON	ON	ON
32.2	28.00	700	6-40	ON	ON	ON	ON
33.4	28.50	750	6-38	ON	ON	ON	ON

Do not energize the driver before connecting the LED.

Before use, always check dipswitch settings!

DIP-switch & output current

BK-DEL010-0350Ad

Pin(W) typ.	Output			1	2	3	4
	Prated(w)	Irated(mA)	Voltage(Vdc)				
6.80	4.20	100	6-42	--	ON	ON	ON
8.30	5.25	125	6-42	ON	--	ON	ON
9.80	6.30	150	6-42	--	--	ON	ON
11.3	7.35	175	6-42	--	ON	--	ON
12.9	8.40	200	6-42	--	--	--	ON
12.9	9.45	225	6-42	ON	ON	ON	--
13.2	10.5	250	6-42	--	--	ON	--
13.3	11.0	275	6-40	--	ON	--	--
13.1	10.8	300	6-36	ON	--	--	--
12.8	10.5	350 ★	6-30	--	--	--	--

BK-DEL022-0600Ad

Pin(W) typ.	Output			1	2	3	4
	Prated(w)	Irated(mA)	Voltage(Vdc)				
11.2	9.45	225	6-42	--	ON	ON	ON
12.3	10.50	250	6-42	ON	--	ON	ON
13.5	11.55	275	6-42	--	--	ON	ON
14.6	12.60	300	6-42	--	ON	--	ON
16.9	14.70	350	6-42	--	--	--	ON
19.3	16.80	400	6-42	ON	ON	ON	--
21.6	18.90	450	6-42	--	--	ON	--
23.9	21.00	500	6-42	--	ON	--	--
26.6	23.10	550	6-42	ON	--	--	--
26.4	22.80	600 ★	6-38	--	--	--	--

BK-DEL028-0750Ad

Pin(W) typ.	Output			1	2	3	4
	Prated(w)	Irated(mA)	Voltage(Vdc)				
14.8	12.60	300	6-42	--	ON	ON	ON
17.0	14.70	350	6-42	ON	--	ON	ON
19.4	16.80	400	6-42	--	--	ON	ON
21.6	18.90	450	6-42	--	ON	--	ON
24.1	21.00	500	6-42	--	--	--	ON
26.9	23.10	550	6-42	ON	ON	ON	--
29.2	25.20	600	6-42	--	--	ON	--
31.8	27.30	650	6-42	--	ON	--	--
32.2	28.00	700	6-40	ON	--	--	--
33.4	28.50	750 ★	6-38	--	--	--	--

Remarks:

- ★ It means that this item is the factory default current.
- It means that this channel is OFF.

DALI dimming application

Wiring diagram

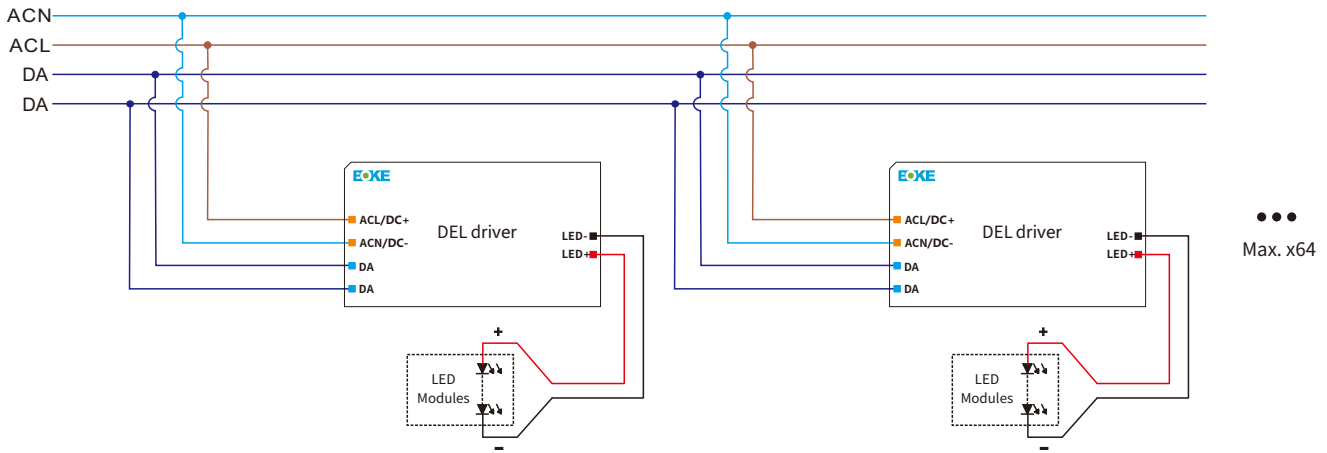

Switch to the DALI dimming mode

- After installation according to the wiring diagram of DALI dimming application, the driver will automatically switch to the DALI control mode after receiving any DALI command.

Remarks:

- Standard DALI control line voltage range: 9.5V to 22.5V, type 16V.
- The two DALI control lines polarity-reversible.
- Max. 64 DALI drivers per DALI control line.
- The maximum distance length of the DALI control line is 300m at $2 \times 1.5\text{mm}^2$.
- DALI bus can be wired together with any mains voltage cables, but separate wiring is recommended.
- The configuration parameters of the driver can be set through the DALI configuration tool or DALI application controller during installation, such as setting device address, group address, power-on level, bus-failure level, scene level, fade time, dimming curve, etc.

Please refer to the table below

Cable size	Distance
$2 \times 0.50\text{mm}^2$	max.100m
$2 \times 0.75\text{mm}^2$	max.150m
$2 \times 1.00\text{mm}^2$	max.200m
$\geq 2 \times 1.50\text{mm}^2$	max.300m

Power-on level :

When the driver is in DALI-2 dimming mode, the factory default level after each power-on is the brightest.

The power-on level can be set through the DALI configuration tool or DALI application controller during installation, and can be set to memory or fixed any brightness (such as off, darkest, 50%, etc.).

Note: The recommended setting for the default factory power-on level of the DALI-2 driver is the brightest in the DALI-2 standard.

Dimming curve

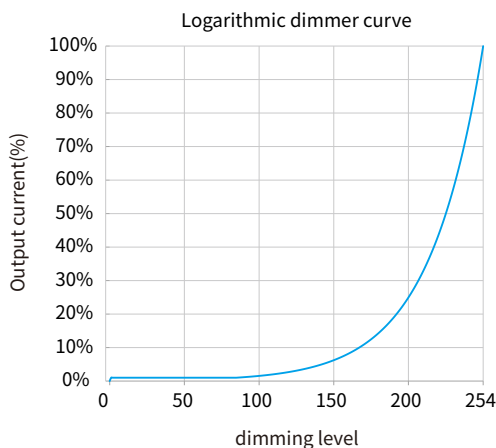

Remarks: The dimming curve can be selected by DALI configuration. The default is logarithmic dimming curve.

pushDIM dimming application

Wiring diagram

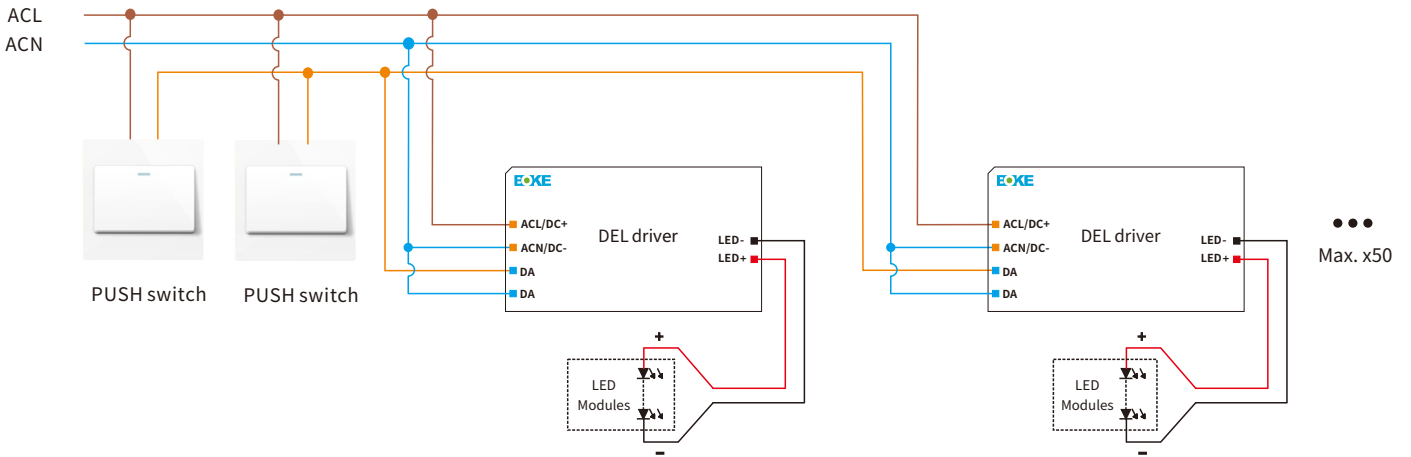

Switch to the pushDIM dimming mode

- After installation according to the wiring diagram of pushDIM dimming application, short press the pushbutton 1 times or short press the pushbutton 5 times quickly within 3s , the driver will automatically switch to the pushDIM dimming mode.

Remarks:

Max. 50 drivers per pushDIM control line.

Turn on or turn off:short press pushbutton for 0.2-1s.

Dimming: long press pushbutton for 1-5s.

Power on status: after power on,the light state will be the same as the lighting on state.

If the light is on before power on,the light will be on after power on again,brightness will be the same as the last lighting on brightness.

If the light is off before power off,the light will be off after power on again,short press the pushbutton,then the light will be on,the brightness will be the same as the last brightness.

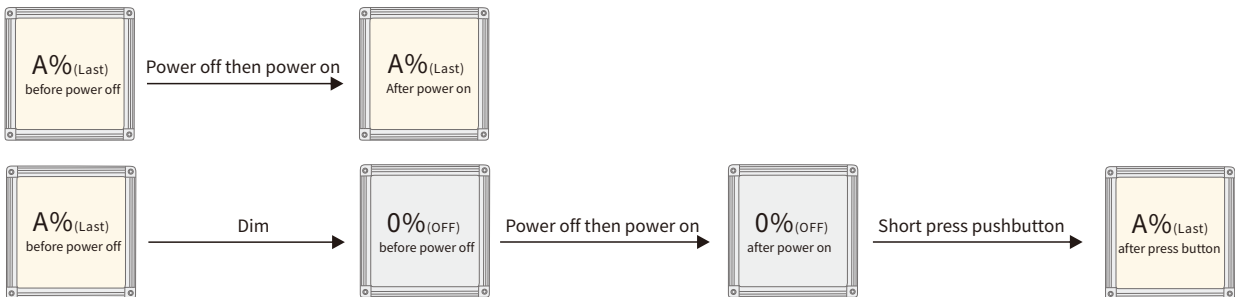

Multiple lights synchronize control operation

method 1:

Step 1:long press the pushbutton,confirm each light is on.

Step 2:short press the pushbutton,confirm each light is off.

Step 3:long press the pushbutton,confirm each light is from darkest to brightest and all the lights are synchronous.

method 2:

- Long press the pushbutton 15s,all lights output to the brightest state.

Installation

Mechanical dimensions

Unit:mm

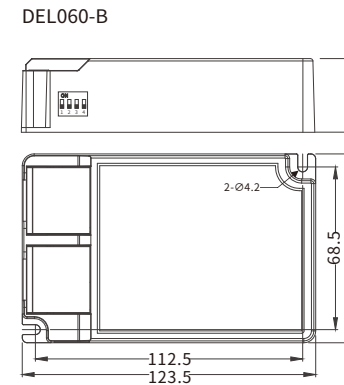
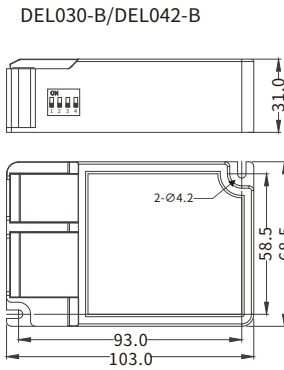
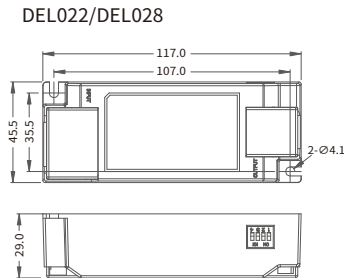
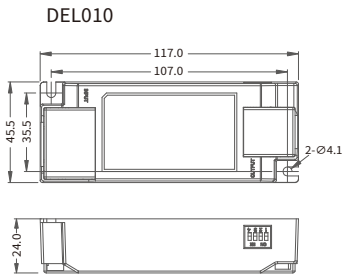

INPUT

Numbering	function	colour
1	ACL/DC+	orange
2	ACN/DC-	orange
3	DA	blue
4	DA	blue

Input wire

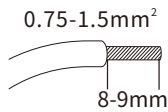

OUTPUT

Numbering	function	colour
1	LED-	black
2	LED+	red

Output wire

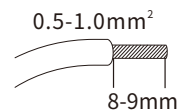

Installation note

Hot plug-in

- Hot plug-in is not supported due to residual output voltage of > 0 V.
- If a LED load is connected the device has to be restarted.
- Restart can be achieved by re-powering the driver or executing a on/off command (action) through the control interface (DALI, pushDIM)

Wiring guidelines

- All connections must be kept as short as possible to ensure good EMI behaviour.
- Mains leads should be kept apart from LED Driver and other leads (ideally 5 – 10 cm distance)
- Max. length of output wires is 2 m.
- Incorrect wiring can damage LED modules.

Installation requirements

- The driver should be installed in a dry, acid-free, oil-free, fat-free environment.
- The installation ambient temperature of the drive shall not exceed the value of Ta at any time.
- The temperature of the mounting surface of the driver should be lower than 40°C
- The driver should keep a certain distance from the heating stuff (such as the luminaire radiator).
- If the driver is used externally (it needs to be used with the accessories), the installation of the driver should also meet the following conditions:
 - 1.The driver should be a certain distance between the drivers, as shown in Figure 1.
 - 2.The driver keeps a certain distance from surrounding objects, as shown in Figure 2.

Mounting screw specifications and torque

- Max. torque at the clamping screw: 0.5 Nm / M4

Replace LED module

1. Mains off
2. Remove LED module
3. Wait for 5 seconds
4. Connect LED module again

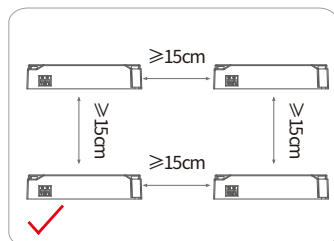
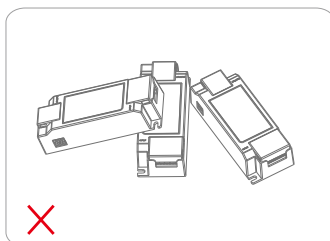

Figure 1

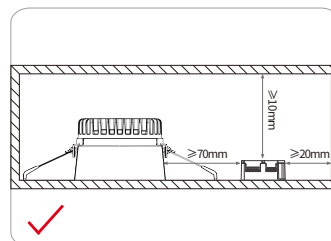
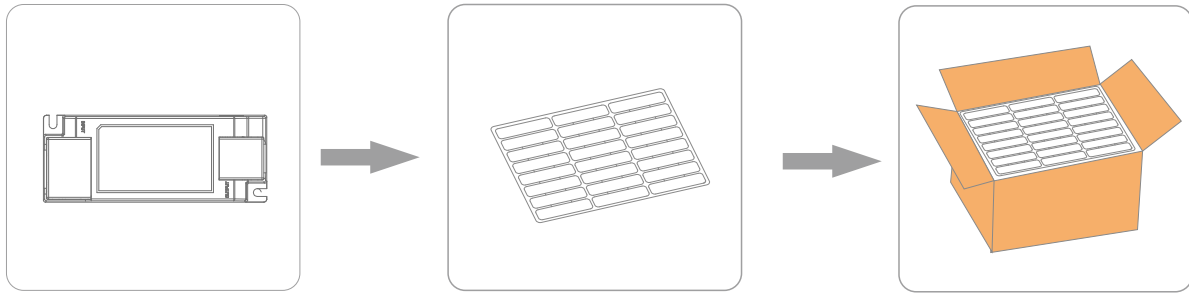

Figure 2

Packaging

Optional 1: factory default



Product

Blister

24pcs×3layer=72pcs/CIN
 16pcs×4layer=64pcs/CIN
 24pcs×2layer=48pcs/CIN
 9pcs×4layer=36pcs/CIN

Model	Product size	Weight	Blister size	Carton size	Qty/carton	N.W	G.W
DEL010	L117*W45.5*H24mm	83g	L430*W340*H47mm	L450*W350*H180mm	72pcs	5.98kg	7.00kg
DEL022	L117*W45.5*H29mm	104g	L430*W340*H47mm	L450*W350*H180mm	72pcs	7.49kg	8.50kg
DEL028	L117*W45.5*H29mm	165g	L430*W340*H47mm	L450*W350*H130mm	48pcs	7.92kg	8.93kg
DEL030-B	L103*W68.5*H31mm	138g	L480*W330*H40mm	L490*W340*H165mm	64pcs	8.83kg	9.98kg
DEL042-B	L103*W68.5*H31mm	167g	L480*W330*H40mm	L490*W340*H165mm	64pcs	10.7kg	11.8kg
DEL060-B	L123*W78.5*H31mm	248g	L435*W345*H40mm	L450*W350*H180mm	36pcs	8.93kg	10.0kg

Optional 2:

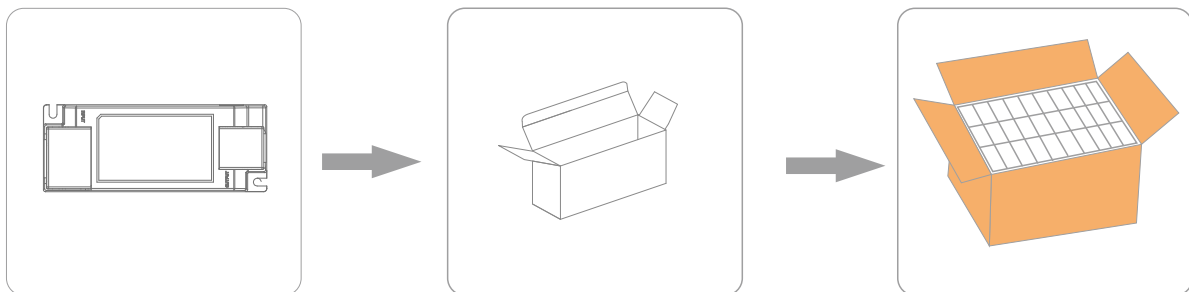

Product

Packaging

18pcs×3layer=54pcs/CIN
 24pcs×2layer=48pcs/CIN
 18pcs×2layer=36pcs/CIN

Model	Product size	Weight	Packaging size	Carton size	Qty/carton	N.W	G.W
DEL010	L117*W45.5*H24mm	84g	L140*W35*H50mm	L345*W310*H170mm	54pcs	4.54kg	6.10kg
DEL022	L117*W45.5*H29mm	104g	L140*W35*H50mm	L345*W310*H170mm	54pcs	5.62kg	7.18kg
DEL028	L117*W45.5*H29mm	165g	L140*W35*H50mm	L345*W310*H170mm	54pcs	8.91kg	10.5kg
DEL030-B	L103*W68.5*H31mm	138g	L130*W38*H85mm	L415*W330*H190mm	48pcs	6.62kg	7.72kg
DEL042-B	L103*W68.5*H31mm	167g	L130*W38*H85mm	L415*W330*H190mm	48pcs	8.00kg	9.11kg
DEL060-B	L123*W79.5*H31mm	248g	L140*W40*H100mm	L380*W295*H220mm	36pcs	8.93kg	10.0kg

Additional information

1. This product can only be used outside the light body, Can not be used inside of the light, and it must be used within the specified working environment.
2. The life and MTBF of the product are for reference only, and do not represent a warranty statement.
3. For more information, please send an email to info@bokedriver.com.